

# TOKISTAR Tapelight

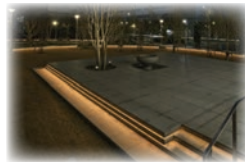

TOKISTAR LIGHTING



# Tapelight Systems

For 50 years, Tokistar® has been providing accent lighting to the hospitality industry for use in hotels, casinos, restaurants, and many other applications. Our Tapelight features low-profile flexible cables, enabling them to fit in small niches and conform to any shape.

Tapelight operates from low-voltage power supplies and the LEDs are easily replaceable. The result is a safe and energy-efficient lighting system easily maintained and looking pristine every day of the year.



**TLP Series** creates an eye-catching display on this restaurant window.

**Several LED Choices** for greatest efficiency.



**Polycarbonate Sockets** are soldered and bonded to cables.



**Flexible Conductor** easily conforms to any shape.



## Contents

- Tapelight Systems | 2-3
- Light Sources | 4-5
- TLP Series | 6-7
- LS Series | 8-9
- TLW Series | 10-11
- Accessories | 12-13
- LED Drivers / Dimming | 14-15



**Cover:** LS Tapelight creates a festive atmosphere at this outdoor plaza. Lighting Design: Souk



**LS Series** is easily cut to size on site, and conforms to curves and angles.



**TLW Series** adds motion and excitement to this casino environment.

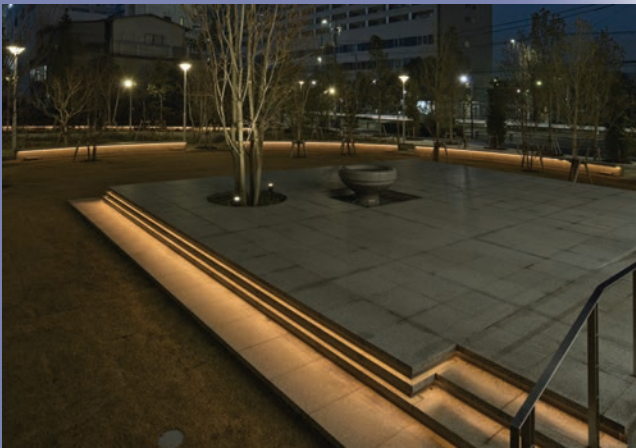

**LS Series** creates a stunning array of light from beneath cantilevered steps.



**Silicone Caps** provide all-environment protection.



**Light Sources** are easily replaced.



**Parallel Wiring** so Tapelight may be cut to size on site.



# TokiLeds®

TokiLeds are durable, energy efficient light sources. White TokiLeds do an outstanding job of emulating true incandescent light. Our selection includes a variety of color temperatures and brightness levels to complement any environment. LEDs dim fluidly from our PWM dimming equipment.



2000K

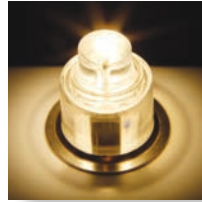

2400K



3000K

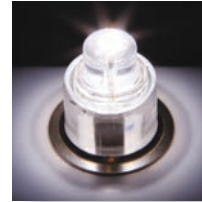

6500K

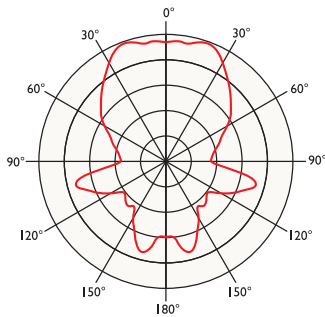

TokiLeds unique phosphor-colored lens reflects light in all directions, resulting in full-range viewing.

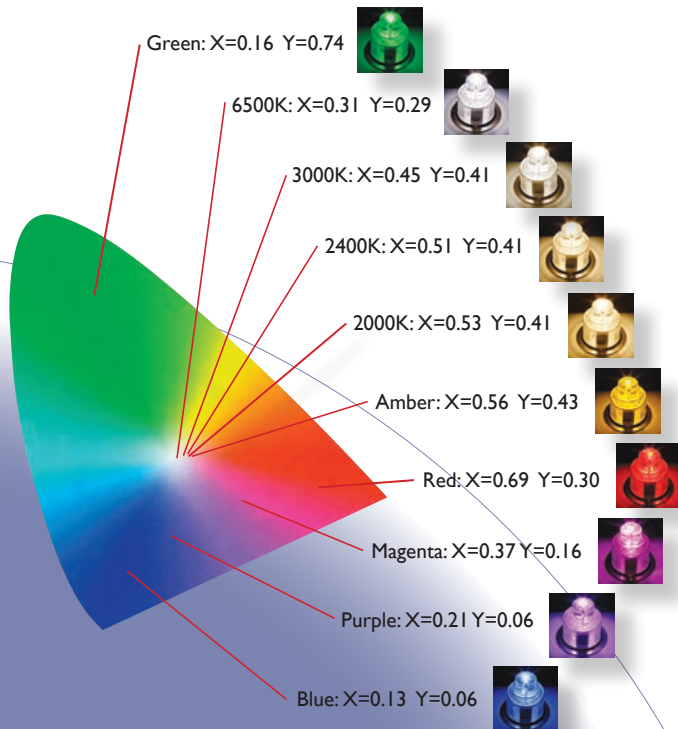

TokiLeds			
Part Number	LED Color	Watts/Volts	Amps
TLED-LV	2000K White	0.1 W / 8VDC	12.5 mA
TLED-WV	2400K White	0.1 W / 8VDC	12.5 mA
TLED-IW	3000K White	0.1 W / 8VDC	12.5 mA
TLED-WH	6500K White	0.1 W / 8VDC	12.5 mA
TLED-LV-HB	2000K White	0.2 W / 8VDC	25.0 mA
TLED-WV-HB	2400K White	0.2 W / 8VDC	25.0 mA
TLED-IW-HB	3000K White	0.2 W / 8VDC	25.0 mA
TLED-WH-HB	6500K White	0.2 W / 8VDC	25.0 mA
TLED-LV-UB	2000K White	0.4 W / 8VDC	50.0 mA
TLED-WV-UB	2400K White	0.4 W / 8VDC	50.0 mA
TLED-IW-UB	3000K White	0.4 W / 8VDC	50.0 mA
TLED-WH-UB	6500K White	0.4 W / 8VDC	50.0 mA
TLED-AM	Amber	0.1 W / 8VDC	12.5 mA
TLED-BL	Blue	0.1 W / 8VDC	12.5 mA
TLED-GR	Green	0.1 W / 8VDC	12.5 mA
TLED-MG	Magenta	0.1 W / 8VDC	12.5 mA
TLED-PL	Purple	0.1 W / 8VDC	12.5 mA
TLED-RD	Red	0.1 W / 8VDC	12.5 mA



# Kinetic TokiLeds

Kinetic TokiLeds are smart LEDs with a microchip to create flashing, cross-fading or strobing effects. LEDs operate independently for a totally random effect.

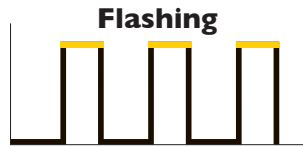

For twinkling effects, the cycle is 0.5 Hz. Faster scintillating effects have a cycle of 4 Hz.

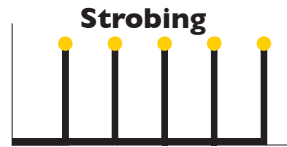

Strobing LEDs create distinct and momentary bright-white flashes of light.



Cross-Fading LEDs smoothly ramp up to full brightness, then gradually fade to off.

Kinetic TokiLeds			
Part Number	Effect	Color	Watts/Volts
KLED-WW-SF	Slow Flash / 0.5 Hz	2400K White	0.20 W / 8VDC
KLED-WW-CF	Cross-Fade	2400K White	0.20 W / 8VDC
KLED-IW-FF	Fast Flash / 4 Hz	3000K White	0.20 W / 8VDC
KLED-IW-SF	Slow Flash / 0.5 Hz	3000K White	0.20 W / 8VDC
KLED-IW-CF	Cross-Fade	3000K White	0.20 W / 8VDC
KLED-WH-ST	Strobe / 1.1 Hz	6500K White	0.27 W / 8VDC

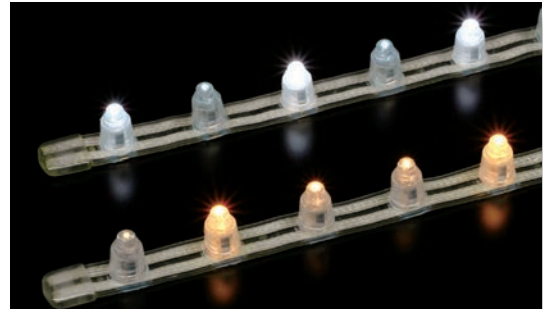

# P4 LEDs

For interior applications, P4 Series LEDs are ideal for indirect lighting applications. With 120 degree optics, they concentrate light on the reflective surface.

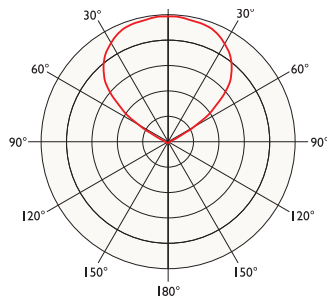

P4 LEDs			
Part Number	Color	Watts/Volts	Amps
PLED-IW	3000K White	0.24 W / 8VDC	30 mA
PLED-WH	6500K White	0.24 W / 8VDC	30 mA
PLED-AM	Amber	0.24 W / 8VDC	30 mA
PLED-BL	Blue	0.24 W / 8VDC	30 mA
PLED-GR	Green	0.24 W / 8VDC	30 mA
PLED-RD	Red	0.24 W / 8VDC	30 mA

Combining different colors on the same fixture, can create a wide range of blended colors

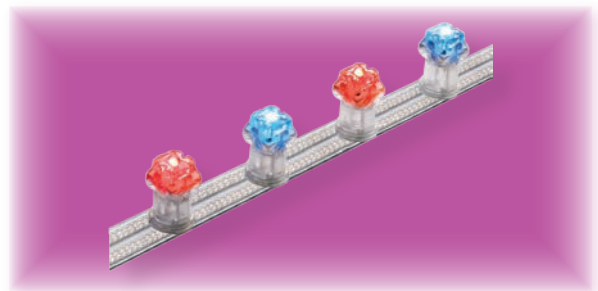
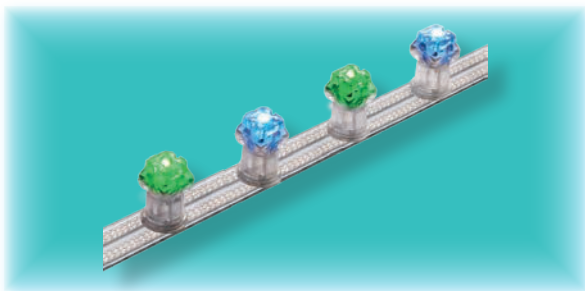



# TLP Series

TLP Series has set an industry standard for interior accent lighting since its introduction. Lamp sockets are soldered and bonded to highly flexible PVC cables for long-term reliability, and fixtures can be trimmed on site for a precise fit.

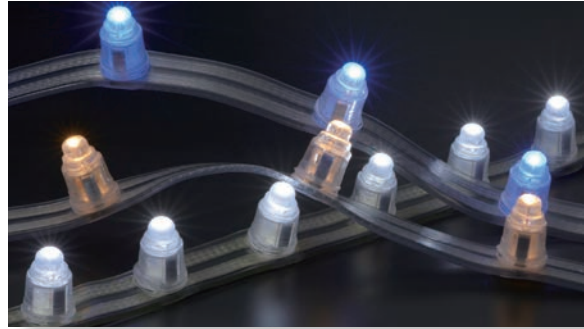

As an indirect light source from concealed areas, TLP Tapelight produces stylish and subtle accents on reflective surfaces.



In exposed applications, TLP Tapelight highlights architectural features with distinct points of light.

## Specifications

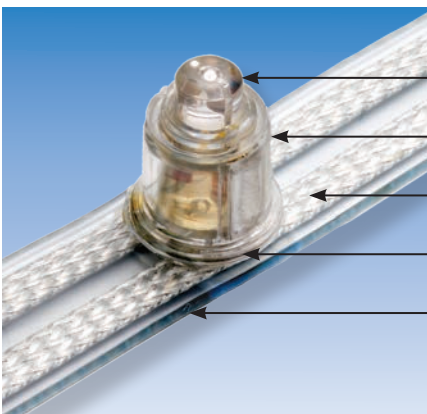

**Light Sources** are LEDs

**Polycarbonate Sockets** with flammability rating UL 94V-0

**Flexible Braided Conductors** are plated copper and rated 12 amps

**Sockets** are soldered and ultrasonically bonded to cable

**Insulation** is UV-stabilized flexible PVC with flammability rating UL 94 HB



## How to Specify

After selecting the most suitable light source for the application, refer to one of these charts with TokiLeds, Kinetic TokiLeds or P4 LEDs.

The next step is to select the appropriate socket spacing. For indirect applications, closer spacing provides the most uniform wash of light. Intermediate and wider socket spacing is the best choice for accenting architectural features with distinct points of light.

**0.10/0.20 Watt LED**

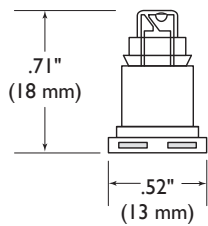

**0.27/0.40 Watt LED**

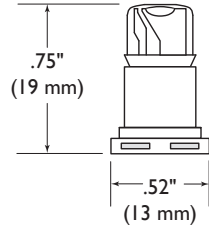

## TLP - 80 - WW

Socket Spacing		TokiLeds			
Code	Inches (mm)	Code	Color	Style	Watts/Volts
<b>30</b>	1.2" (30 mm)	<b>LW</b>	2000K White	Standard	0.10 W / 8VDC
<b>50</b>	2.0" (50 mm)	<b>WW</b>	2400K White	Standard	0.10 W / 8VDC
<b>80</b>	3.0" (80 mm)	<b>IW</b>	3000K White	Standard	0.10 W / 8VDC
<b>100</b>	4.0" (100 mm)	<b>WH</b>	6500K White	Standard	0.10 W / 8VDC
<b>150</b>	6.0" (150 mm)	<b>LW-HB</b>	2000K White	High Brightness	0.20 W / 8VDC
<b>300</b>	12.0" (300 mm)	<b>WW-HB</b>	2400K White	High Brightness	0.20 W / 8VDC
		<b>IW-HB</b>	3000K White	High Brightness	0.20 W / 8VDC
		<b>WH-HB</b>	6500K White	High Brightness	0.20 W / 8VDC
		<b>LW-UB</b>	2000K White	Ultra-Bright	0.40 W / 8VDC
		<b>WW-UB</b>	2400K White	Ultra-Bright	0.40 W / 8VDC
		<b>IW-UB</b>	3000K White	Ultra-Bright	0.40 W / 8VDC
		<b>WH-UB</b>	6500K White	Ultra-Bright	0.40 W / 8VDC
		<b>KLED-WW-SF</b>	2400K White	Slow Flashing	0.20 W / 8VDC
		<b>KLED-WW-CF</b>	2400K White	Cross-Fading	0.20 W / 8VDC
		<b>KLED-IW-FF</b>	3000K White	Fast Flashing	0.20 W / 8VDC
		<b>KLED-IW-SF</b>	3000K White	Slow Flashing	0.20 W / 8VDC
		<b>KLED-IW-CF</b>	3000K White	Cross-Fading	0.20 W / 8VDC
		<b>KLED-WH-ST</b>	6500K White	Strobe	0.27 W / 8VDC
		<b>AM</b>	Amber	Standard	0.10 W / 8VDC
		<b>BL</b>	Blue	Standard	0.10 W / 8VDC
		<b>GR</b>	Green	Standard	0.10 W / 8VDC
		<b>MG</b>	Magenta	Standard	0.10 W / 8VDC
		<b>PL</b>	Purple	Standard	0.10 W / 8VDC
		<b>RD</b>	Red	Standard	0.10 W / 8VDC

## TLP - 80 - P4IW

Socket Spacing		P4 LEDs		
Code	Inches (mm)	Code	Color	Watts/Volts
<b>30</b>	1.2" (30 mm)	<b>P4IW</b>	3000K White	0.24 W / 8VDC
<b>50</b>	2.0" (50 mm)	<b>P4WH</b>	6500K White	0.24 W / 8VDC
<b>80</b>	3.0" (80 mm)	<b>P4AM</b>	Amber	0.24 W / 8VDC
<b>100</b>	4.0" (100 mm)	<b>P4BL</b>	Blue	0.24 W / 8VDC
<b>150</b>	6.0" (150 mm)	<b>P4GR</b>	Green	0.24 W / 8VDC
<b>300</b>	12.0" (300 mm)	<b>P4RD</b>	Red	0.24 W / 8VDC

**P4-LED**

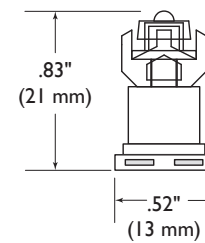

### Fixture Length

To minimize voltage drop and keep conductors safely within their rating, do not exceed the maximum lengths shown for each independent length of Tapelight.

Spacing	LED				
	0.1 Watt	0.2 Watt	0.24 Watt	0.27 Watt	0.4 Watt
1.2" (30 mm)	40' (12.0 M)	20' (6.0 M)	16' (5.0 M)	14' (4.4 M)	10' (3.0 M)
2.0" (50 mm)	66' (20.0 M)	33' (10.0 M)	27' (8.3 M)	24' (7.4 M)	16' (5.0 M)
3.0" (80 mm)	88' (26.8 M)	50' (15.2 M)	43' (13.2 M)	37' (11.3 M)	25' (8.0 M)
4.0" (100 mm)	98' (30.0 M)	66' (20.0 M)	54' (16.6 M)	48' (14.8 M)	33' (10.0 M)
6.0" (150 mm)	120' (36.6 M)	90' (27.4 M)	81' (24.9 M)	66' (20.3 M)	50' (15.0 M)
12.0" (300 mm)	164' (50.0 M)	126' (38.4 M)	102' (31.2 M)	93' (28.4 M)	82' (25.0 M)



# LS Series

LS Series Tapelight is the ideal choice for exterior applications. UV-stabilized cables with larger conductors extend operating life and minimize voltage drop. These features offer many benefits in large-scale perimeter lighting and indirect applications with closer socket spacing.

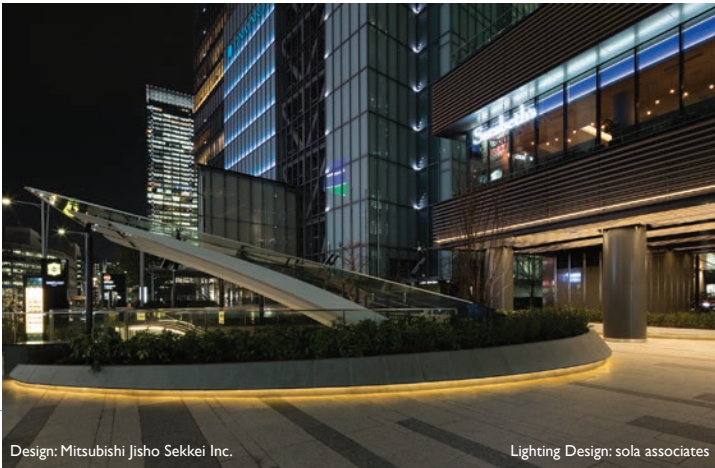

Design: Mitsubishi Jisho Sekkei Inc.

Lighting Design: sola associates

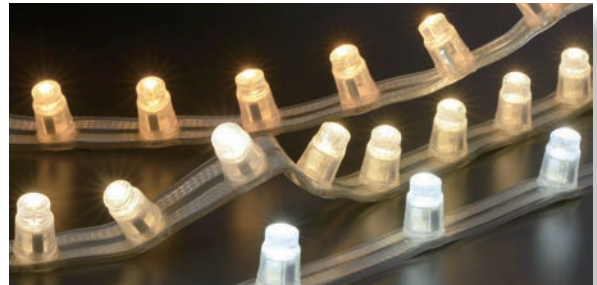

## Specifications

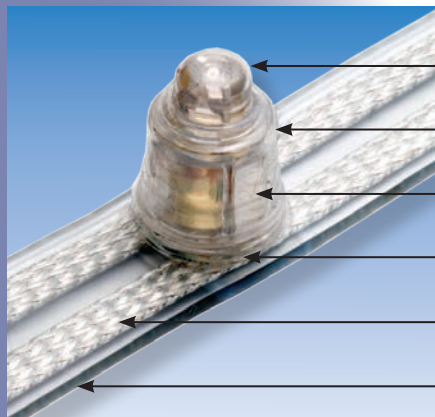

- Light Sources** are LEDs
- Polycarbonate Sockets** with flammability rating UL 94V-0
- Silicone Caps** provide protection in all environments
- Sockets** are soldered and ultrasonically bonded to cable
- Flexible Braided Conductors** are plated copper and rated 12 amps
- Insulation** is UV-stabilized flexible PVC with flammability rating UL 94 HB



Wet-Location Listed



# How to Specify

Select the appropriate TokiLed as the light source. Next, decide on cable color and the suitable socket spacing. For indirect applications, closer socket spacing provides a more uniform wash of light. When accenting with distinct points of light, wider socket spacing is the best choice. For perimeter lighting on buildings viewed from greater distances, 6" or 12" spacing are the most popular selections.

## LSW - 30 - WH-HB - WP

Series		Socket Spacing		TokiLeds			
Code	Cable Color	Code	Inches (mm)	Code	Color	Style	Watts/Volts
<b>LSW</b>	White	<b>30</b>	1.2" (30 mm)	<b>LW</b>	2000K White	Standard	0.10 W / 8VDC
<b>LSC</b>	Clear	<b>50</b>	2.0" (50 mm)	<b>WW</b>	2400K White	Standard	0.10 W / 8VDC
<b>LSB*</b>	Brown	<b>80</b>	3.0" (80 mm)	<b>IW</b>	3000K White	Standard	0.10 W / 8VDC
		<b>100</b>	4.0" (100 mm)	<b>WH</b>	6500K White	Standard	0.10 W / 8VDC
		<b>150</b>	6.0" (150 mm)	<b>LW-HB</b>	2000K White	High Brightness	0.20 W / 8VDC
		<b>300</b>	12.0" (300 mm)	<b>WW-HB</b>	2400K White	High Brightness	0.20 W / 8VDC
				<b>IW-HB</b>	3000K White	High Brightness	0.20 W / 8VDC
				<b>WH-HB</b>	6500K White	High Brightness	0.20 W / 8VDC
				<b>LW-UB</b>	2000K White	Ultra-Bright	0.40 W / 8VDC
				<b>WW-UB</b>	2400K White	Ultra-Bright	0.40 W / 8VDC
				<b>IW-UB</b>	3000K White	Ultra-Bright	0.40 W / 8VDC
				<b>WH-UB</b>	6500K White	Ultra-Bright	0.40 W / 8VDC
				<b>KLED-WW-SF</b>	2400K White	Slow Flashing	0.20 W / 8VDC
				<b>KLED-WW-CF</b>	2400K White	Cross-Fading	0.20 W / 8VDC
				<b>KLED-IW-FF</b>	3000K White	Fast Flashing	0.20 W / 8VDC
				<b>KLED-IW-SF</b>	3000K White	Slow Flashing	0.20 W / 8VDC
				<b>KLED-IW-CF</b>	3000K White	Cross-Fading	0.20 W / 8VDC
				<b>KLED-WH-ST</b>	6500K White	Strobe	0.27 W / 8VDC
				<b>AM</b>	Amber	Standard	0.10 W / 8VDC
				<b>BL</b>	Blue	Standard	0.10 W / 8VDC
				<b>GR</b>	Green	Standard	0.10 W / 8VDC
				<b>MG</b>	Magenta	Standard	0.10 W / 8VDC
				<b>PL</b>	Purple	Standard	0.10 W / 8VDC
				<b>RD</b>	Red	Standard	0.10 W / 8VDC

\* Brown available in 4", 6" and 12" spacing only.



LS Series Tapelight with TokiLeds includes silicone caps for protection in all environments.

### 0.10/0.20 Watt LED

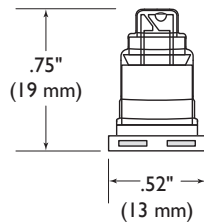

### 0.27/0.40 Watt LED

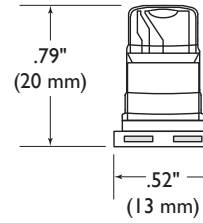

### Fixture Length

To minimize voltage drop and keep conductors safely within their rating, do not exceed the maximum lengths shown for each independent length of Tapelight.

Spacing	LED			
	0.1 Watt	0.2 Watt	0.27 Watt	0.4 Watt
1.2" (30 mm)	40' (12.0 M)	20' (6.0 M)	14' (4.4 M)	10' (3.0 M)
2.0" (50 mm)	66' (20.0 M)	33' (10.0 M)	24' (7.4 M)	16' (5.0 M)
3.0" (80 mm)	88' (26.8 M)	50' (15.2 M)	37' (11.3 M)	25' (8.0 M)
4.0" (100 mm)	98' (30.0 M)	66' (20.0 M)	48' (14.8 M)	33' (10.0 M)
6.0" (150 mm)	120' (36.6 M)	90' (27.4 M)	66' (20.3 M)	50' (15.0 M)
12.0" (300 mm)	164' (50.0 M)	126' (38.4 M)	93' (28.4 M)	82' (25.0 M)



# TLW Series

Nothing adds interest to an environment like an eye-catching display of colorful and animated lighting. TLW Series provides multi-channel chasing effects for interior and outdoor venues. Our broad range of TokiLeds offer numerous options in creating brilliant effects.



TLW Series uses three conductors to achieve a perfectly linear placement of LEDs.



### TokiLed/TokiLed-HB

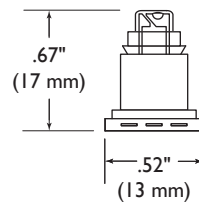

### TokiLed w/WP

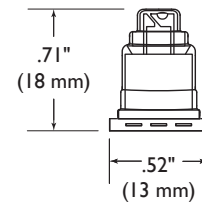

### Fixture Length

To minimize voltage drop and keep conductors safely within their rating, do not exceed the maximum lengths shown for each independent length of Tapelight.

Spacing	LED	
	0.15 Watt	0.30 Watt
2.0" (50 mm)	43' (13.1 M)	19' (5.8 M)
4.0" (100 mm)	84' (25.6 M)	40' (12.0 M)

## Specifications

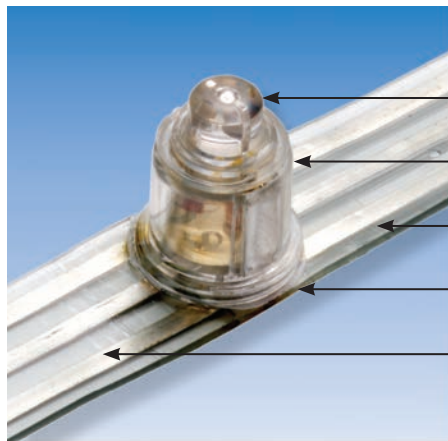

**Light Sources** are LEDs

**Polycarbonate Sockets** with flammability rating UL 94V-0

**Flexible Conductors** are plated copper and rated 5 amps

**Sockets** are soldered and ultrasonically bonded to cable

**Insulation** is UV-stabilized flexible PVC with flammability rating UL 94 HB



Wet-Location Listed



## How to Specify

Select your choice of TokiLeds as the light source. Any combination of LEDs can be mixed on the same fixture.

When selecting socket spacing, consider that not all LEDs are illuminated at the same time. In a light-chase mode, every 4th LED is on. In a shadow-chase mode, three out of every four LEDs are on.

## TLW - 50 - WW-HB - WP

Socket Spacing		Light Source			Optional Cap	
Code	Inches (mm)	Code	Style	Watts / Volts	Code	Description
<b>50</b>	2.0" (50 mm)	<b>LW</b>	2000K White LED	0.15 W / 12 VAC	<b>WP</b>	Silicone Caps
<b>100</b>	4.0" (100 mm)	<b>WW</b>	2400K White LED	0.15 W / 12 VAC		
		<b>IW</b>	3000K White LED	0.15 W / 12 VAC		
		<b>WH</b>	6500K White LED	0.15 W / 12 VAC		
		<b>LW-HB</b>	HB 2000K White LED	0.30 W / 12 VAC		
		<b>WW-HB</b>	HB 2400K White LED	0.30 W / 12 VAC		
		<b>IW-HB</b>	HB 3000K White LED	0.30 W / 12 VAC		
		<b>WH-HB</b>	HB 6500K White LED	0.30 W / 12 VAC		
		<b>AM</b>	Amber LED	0.15 W / 12 VAC		
		<b>BL</b>	Blue LED	0.15 W / 12 VAC		
		<b>GR</b>	Green LED	0.15 W / 12 VAC		
		<b>MG</b>	Magenta LED	0.15 W / 12 VAC		
		<b>PL</b>	Purple LED	0.15 W / 12 VAC		
		<b>RD</b>	Red LED	0.15 W / 12 VAC		



Silicone Caps provide protection in all environments.

## Lighting Controller / TC-400BB

TLW Series Tapelight requires the use of our TC-400BB Controller. Each controller features a variety of patterns and speed control. These units can operate independently of each other, or they may be linked together to sequence all lights in unison. The TC-400BB accepts a 12VAC input. Dimensions: 1-1/2" x 4-3/4" x 6-1/8"



### Capacity for Class 2 Operation:

TokiLeds 0.15 Watt/12VAC LEDs: 400 each - Total 60 Watts  
 TokiLeds 0.30 Watt/12VAC LEDs : 200 each - Total 60 Watts

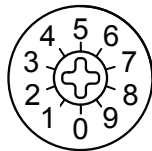

### Dial Settings

- 0) 3 LEDs on 1 LED off Forward
- 1) 2 LEDs on 2 LEDs off Forward
- 2) 1 LED on 3 LEDs off Forward
- 3) 3 LEDs on 1 LED off Reverse
- 4) 2 LEDs on 2 LEDs off Reverse
- 5) 1 LED on 3 LEDs off Reverse
- 6) Flashing alternately
- 7) On / Off
- 8-9) Not used

Up to 20 each TC-400BB controllers can be linked together with RJ11 cable.

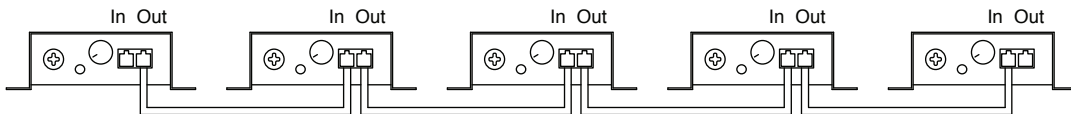

## Class 2 Transformers

Class 2/12VAC output transformers are for use with our TLW series. These transformers have inherent secondary circuit protection. Primary input is 120 VAC/60 Hz. Transformers are provided within a NEMA 3R enclosure.

Class 2 - 12 Volt						
Part Number	Outputs	D	H	W	Weight	
C2-60-12V	1 @ 60 Watt / 12VAC	2.3"	6.6"	2.6"	3 lbs	
C2-120-12V	2 @ 60 Watt / 12VAC	5.0"	7.0"	5.0"	11 lbs	
C2-240-12V	4 @ 60 Watt / 12VAC	5.0"	7.0"	5.0"	12 lbs	
C2-300-12V	5 @ 60 Watt / 12VAC	5.0"	7.0"	5.0"	12 lbs	



# Accessories

## Mounting Devices

Tokistar offers a wide variety of mounting devices. The proper selection is determined by the surface Tapelight is attached to. In addition to the devices shown, construction adhesives capable of adhering well to PVC may be used.

Mounting Devices	
Part Number	Description
<b>TP-01</b>	Mounting Bracket
<b>WM-1211</b>	36 ft. roll Adhesive Tape
<b>RC-S</b>	Mounting Track
<b>SH-02</b>	Metal Fastener

### Bracket

Brackets provide secure mounting. The proper quantity and positioning is determined by the specifics of each application. When turning corners, a device should be used at the start of each bend.

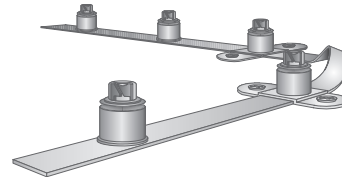
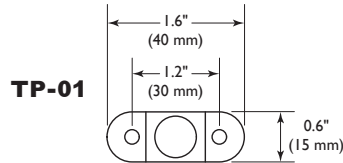
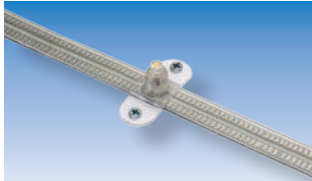

### Adhesive Tape

Adhesive tape works best on smooth surfaces. The WM-1211 is a 36 ft. roll suitable for interior and exterior use with all Tapelight Series.

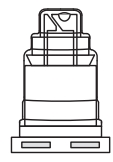

**WM-1211**

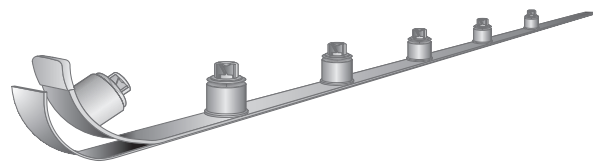

### Mounting Track

The RC-S is a semi-rigid polycarbonate track suitable for use with all Tapelight Series. The track can be securely mounted in place with screws to any surface. This provides a smooth surface to apply adhesive tape, and ensure perfect linear integrity.

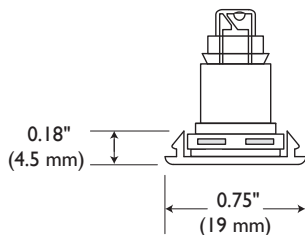

**RC-S**

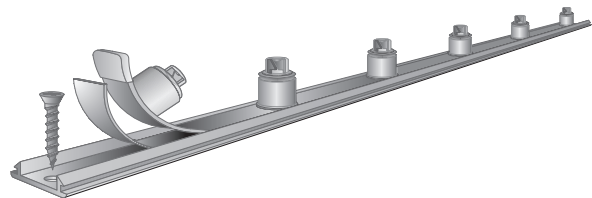

### Panel Fastener

The SH-02 metal fasteners are used to securely lock sockets in place for panel mounting. Tapelight sockets are pushed through the hole in the panel from behind, and the fastener is pressed in place from above.

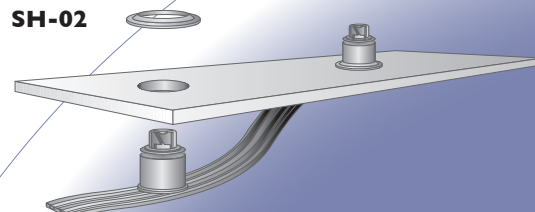
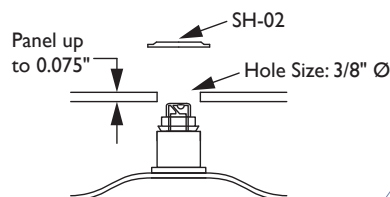



## Cord Protectors and End Caps

Cord Protectors are required to insulate the lead wire soldered to the beginning of each Tapelight, and End Caps are attached to the end.

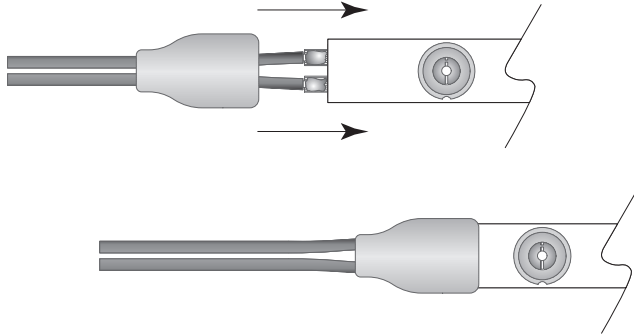

Cord Protectors		
Part Number	Color	Series
<b>ECL-BK</b>	Black	LS
<b>ECL-WH</b>	White	LS
<b>ECL-CL</b>	Clear	LS & TLP
<b>ECW-L</b>	Clear	TLW



End Caps		
Part Number	Color	Series
<b>ECD-BK</b>	Black	LS
<b>ECD-WH</b>	White	LS
<b>ECD-CL</b>	Clear	LS, TLP & TLW

## Decorative Channels

Decorative Channels provide added appeal in high-visibility applications. Tapelight is installed to the base with adhesive tape and the clear cover snapped in place. Channels may be used with all TokiLeds.

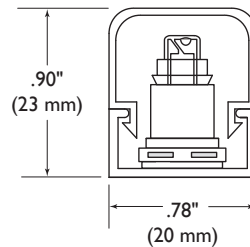
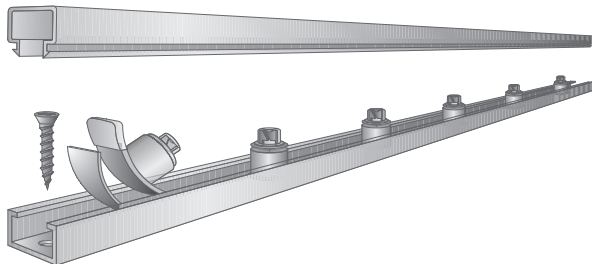

Part Number	Description
<b>TXB-W</b>	PVC White Base
<b>TXS-CS</b>	Polycarbonate Lens
<b>EC-W</b>	White End Cap

## Silicone Caps

Silicone caps provide protection to LS and TLW Series Tapelight for exterior use.

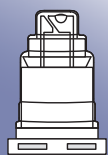

**WP-L01C**

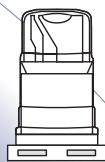

**WP-L02C**



Part Number	Description
<b>WP-L01C</b>	0.1 and 0.2 Watt Cap
<b>WP-L02C</b>	0.27 and 0.40 Watt Cap



# LED Drivers & Dimming

Tokistar Tapelight is ETL Listed when operated from our LED Drivers.



## LDR8-40

Tokistar's LDR8-40 is a 40 Watt Class 2 LED driver used to convert an AC input into an 8VDC output. It may be operated from a wide range of input voltages and is wet-location listed.

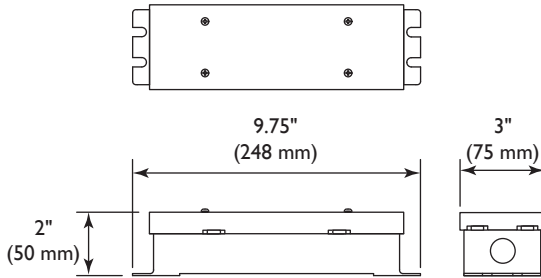

### Specifications

Input Range: 100~240VAC  
Frequency Range: 50/60 Hz  
Output: 8VDC (Adjustable +10% / -25%)  
Max. Output Current: 5.0A  
Max. Output Power: 40W  
Protection: Overload, Overcurrent, Short Circuit  
Operating Temperature: -30°C to +60°C

### Mechanical Specifications

Dimensions: 3" x 9.75" x 2"  
Weight: 1.94 lbs  
Enclosure Rating: Nema 3/IP65  
Mounting: Flange Mount  
Connection: Knockouts for 1/2" Conduit

### LED Capacity

0.10 Watt LEDs: 400 pieces  
0.20 Watt LEDs: 200 pieces  
0.24 Watt LEDs: 166 pieces  
0.27 Watt LEDs: 148 pieces  
0.40 Watt LEDs: 100 pieces

## LDR8-80

Tokistar's LDR8-80 is a dual output Class 2 LED driver with two independent 40 Watt outputs. It may be operated from a wide range of input voltages and is wet-location listed.

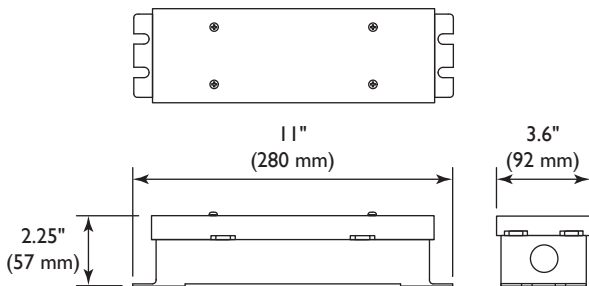

### Specifications

Input Range: 100~240VAC  
Frequency Range: 50/60 Hz  
Output: 8VDC (Adjustable +5% / -30%)  
Max. Output Current: 10.0A (2 @ 5.0A)  
Max. Output Power: 80W (2 @ 40W)  
Protection: Overload, Overcurrent, Short Circuit  
Operating Temperature: -30°C to +60°C

### Mechanical Specifications

Dimensions: 3.6" x 11" x 2.25"  
Weight: 4 lbs  
Enclosure Rating: Nema 3/IP65  
Mounting: Flange Mount  
Connection: Knockouts for 1/2" spec Conduit

### LED Capacity

0.10 Watt LEDs: 800 pieces  
0.20 Watt LEDs: 400 pieces  
0.24 Watt LEDs: 332 pieces  
0.27 Watt LEDs: 296 pieces  
0.40 Watt LEDs: 200 pieces

## 0/1-10VDC Dim Card

### Part #: LDR-DIM

This component is connected to the secondary output of our LED drivers and works from industry-standard 0/1-10VDC dimmers. The output to our fixtures is Pulse Width Modulation (PWM) for flicker-free operation.

Two dimmer cards are required when using our dual output LDR8-80 driver.



Dim Cards are small enough to fit within the wiring compartment of our LDR8-40 LED driver or may be installed externally.

### Technical Specifications:

Control Voltage: 0/1-10VDC  
Input Voltage: 8VDC  
Max. Load: 40 Watts/5 Amps  
Dimming Ratio: 1:10,000  
Weatherability: Damp Location/IP65  
Size: 0.6" x 2.2" x 5.3" Weight: 55g  
Operating Temp: -20°C to 60°C  
Case Material: White Polycarbonate  
Approvals: UL Listed/CE Certified  
Complies with EN55015/FCC Part 15

## LC-1CH-MULTI System

Tokistar's LC-1CH-MULTI Dimmer Pack is compatible with industry-standard dimmers working on DMX or 0/1-10VDC protocol. In the manual mode, a preset light level can be set without the use of an external dimmer.



**Part #: LC-1CH-MULTI**

Technical Specifications:  
 Max. Load: 40 Watts @ 8VDC  
 Environmental Rating: Dry Location/IP20  
 Dimensions: 3/4" x 1-3/4" x 3-1/2"  
 Weight: 50g / 0.11 lbs  
 Listing: ETL Listed/CE Certified  
 Operating Temperature: 0~+50°C

### DMX Mode

In this mode, dimmer packs are addressable and may be used with any controller working on DMX protocol. Up to 36 dimmer packs may be connected in series. For applications exceeding 36 dimmer packs, an additional feed from the DMX dimmer is required. The additional feed(s) can be sent directly from the dimmer, or you may specify DMX Splitters. Consult factory on details of DMX Splitters.

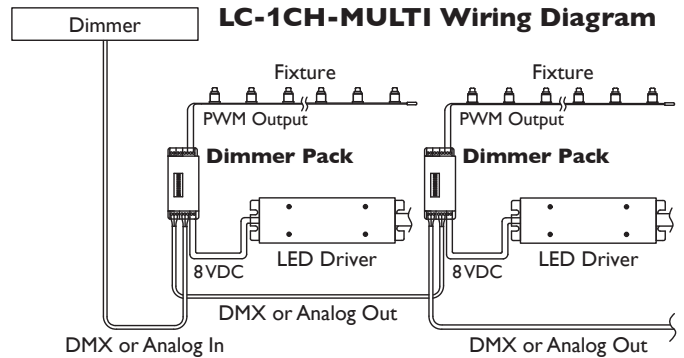

### Analog Mode 0/1-10VDC

For operation from devices using 0/1-10VDC protocol, up to 10 dimmer packs may be connected in series. For applications exceeding 10 dimmer packs, an additional feed from the analog dimming device is required.

## LC Dimming System

This proprietary Dimming System provides full-range dimming of Tape Lighting LEDs. The system components connect with CAT5 cable. Up to 25 dimmer packs may be connected in series if the total length of all CAT5 cable does not exceed 165 feet from the wall dimmer to the last dimmer pack. CAT5 cables are included with units.



**Part #: LC-DMR**

The remote wall dimmer has a rotary dial and on/off switch. Power to the wall dimmer is provided from the LED driver powering the first dimmer pack. The unit installs in a single-gang box.

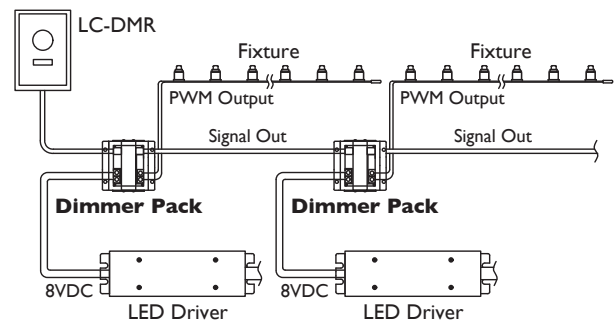

**Part #: LC-1CH-DP**

Each dimmer pack receives an 8VDC input from an LED driver and sends a PWM output to the fixture. Logic input and output is communicated through CAT5 cable. Dimensions: 1-1/2" x 3-1/2" x 4-1/16"

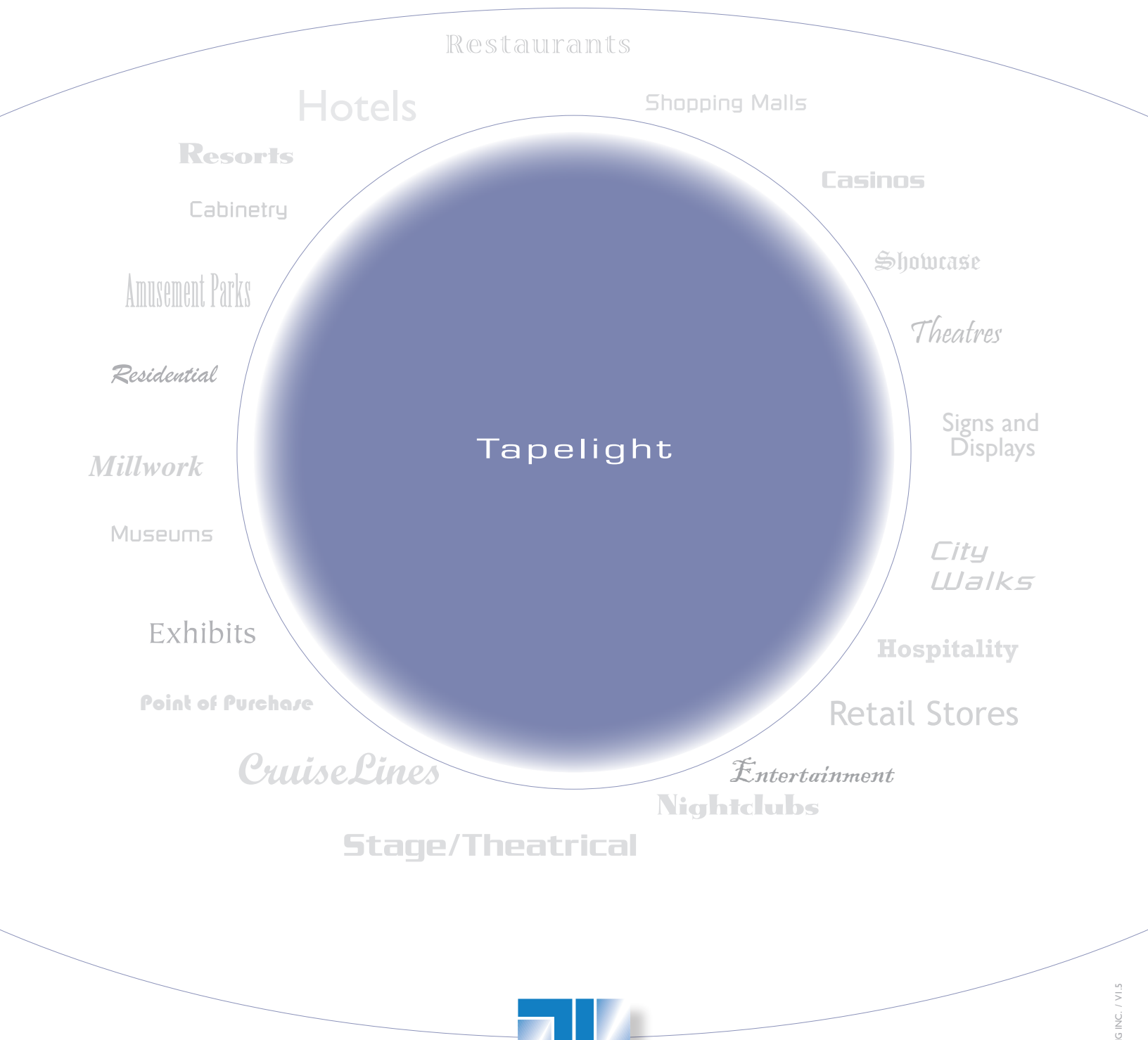

**TOKISTAR® LIGHTING INC.**

1015 E. Discovery Lane • Anaheim, CA 92801  
 Tel: 714.772.7005 • Fax: 714.772.7014 • Toll free in USA: 877.340.7633  
 Email: info@tokistar.com • Website: www.tokistar.com