



# TOKISTAR LIGHTING INSTRUCTION MANUAL

## LC-1CH-MULTI Dimmer Module

### General

The LC-1CH-MULTI Dimmer Pack can be used with any of Tokistar's LED Lighting Systems operating from our 6, 8 or 24 VDC LED Drivers. The maximum rating at 6 and 8 VDC is 5 amps. The maximum rating at 24 VDC is 4 amps.

This unit may be operated on different dimming protocols, which include:

**DMX Mode** - In this mode, each unit is independently addressable. Convenient In-Out terminals are provided for connecting units in series.

**ANALOG Modes** - You may select between 0-10V or 1-10V Analog protocols. Convenient In-Out terminals are provided for connecting units in series.

**MANUAL Mode** - You may select a light intensity the fixtures will operate at. In this case, no external dimming device is required.

### Delivery Packet

Check for transport damage.

You should be in possession of the following items:

- 1 LC-1CH-MULTI
- 1 Manual, 1 Screwdriver, 1 Connecting part

LC-1CH-MULTI

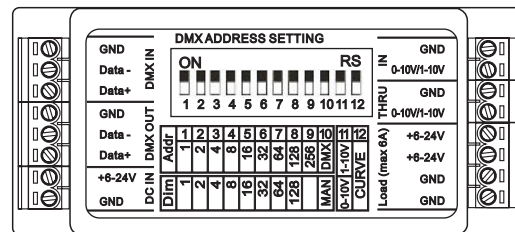

### Technical Specifications

- Power Requirement 6~8VDC / 5A Max., 24VDC / 4A Max.
- Input 2-pin black terminal connector for Power In  
2-pin green terminal connector for Analog In  
3-pin green terminal connector for DMX In
- Output 2-pin orange terminal connector for Analog out  
3-pin orange terminal connector for DMX out  
4-pin green terminal connector for LOAD (5A Max.)
- Housing Black Plastic
- Environmental Rating IP20 / Dry Location Only
- Control Protocol DMX-512 (1990), Analog (0-10 or 1-10VDC)
- Connection Terminal
- Listing CE certified / ETL Listed
- Operation temperature 0 degC to + 50 degC
- Dimensions 3.6" (90mm) L x 1.6" (40mm) W x 0.8" (20mm) H
- Weight 50g / 0.11 lbs

### ⚠ PRECAUTIONS

1. Read all instructions completely before beginning installation.
2. Turn off electricity before beginning installation.
3. All wiring is to be performed by a qualified electrician.
4. Installation must comply with the National Electrical Code, and all applicable codes.
5. Turn main supply to transformer on only after all connections are made and tested.
6. Use only LED Drivers provided by Tokistar with the system.
7. Components must be installed in enclosures suitable for the environment.

# DMX Control Mode

For operation from devices using DMX protocol, flip dip-switch 10 to the "ON" position.

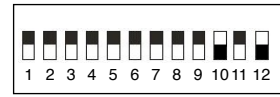

On  
↑  
↓  
Off

DMX is an acronym for Digital Multiplex. This is a universal binary language used as a form of communication between intelligent devices. After setting dip-switch 10 to the "ON" position, you need to set the address on the dimmer pack. If all dimmer packs have the same address setting, all will work in unison. You can set dimmer packs to different addresses, so each one is operating independently.

Each dip-switch on the dimmer pack represents a binary value. A DMX address is set by combining the dip switches so they add up to the value you wish to achieve.

- Dip-Switch 1 address equals 1
- Dip-Switch 2 address equals 2
- Dip-Switch 3 address equals 4
- Dip-Switch 4 address equals 8
- Dip-Switch 5 address equals 16
- Dip-Switch 6 address equals 32
- Dip-Switch 7 address equals 64
- Dip-Switch 8 address equals 128
- Dip-Switch 9 address equals 256

Start CH#	Switches On	Start CH#	Switches On
1	1	11	1,2,4
2	2	12	3,4
3	1,2	13	1,3,4
4	3	14	2,3,4
5	1,3	15	1,2,3,4
6	2,3	:	:
7	1,2,3	:	:
8	4	:	:
9	1,4	:	:
10	2,4	511	1,2,3,4,5,6,7,8,9

### Example 1

Dip Switch	Value
1	= 1
3	= 4
5	= 16
	= 21

### Example 2

Dip Switch	Value
1	= 1
4	= 8
7	= 64
8	= 128
	= 201

## Dimming Curve

There are two settings for the Dimming Curve.

With dip-switch 12 set to the "On" position, the Dimming Curve is Linear.

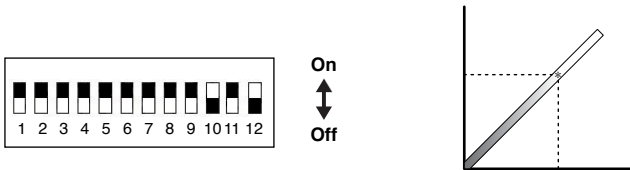

With dip-switch 12 set to the "Off" position, the Dimming Curve is Non-Linear.



## Wiring Details

A maximum of 36 dimmer packs may be connected in series in the DMX Mode. For applications exceeding 36 dimmer packs, an additional feed from the DMX device is required.

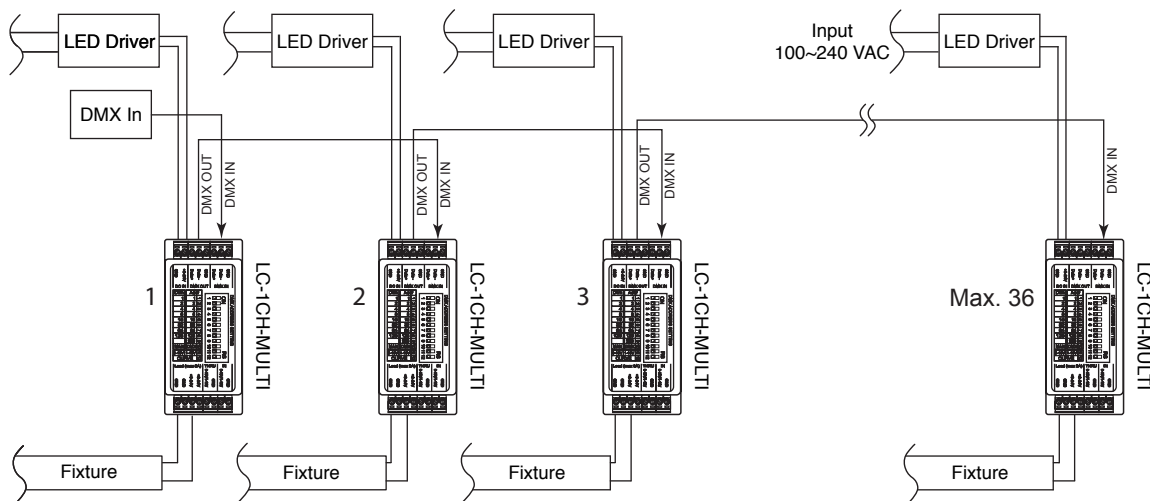

# Analog Setting 1-10VDC

For operation from devices using 1-10VDC protocol, flip dip-switch 11 to the "ON" position.

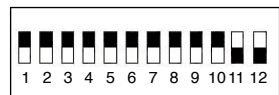

On  
↕  
Off

The 1-10VDC setting is the norm in most cases, and does not require the system to send a separate power signal to the dimming device. The dimming device derives its power from our LED Driver. Additionally, this setting is based upon the protocol 0-1VDC = Off, and other voltage values above 1VDC directly correlate to dim values. A maximum of 10 Dimmer Packs can be connected in series.

## Dimming Curve

In this analog mode, there are two settings for the Dimming Curve.

With dip-switch 12 set to the "On" position, the Dimming Curve is Linear.

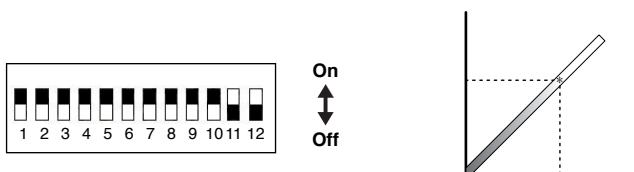

With dip-switch 12 set to the "Off" position, the Dimming Curve is Non-Linear.

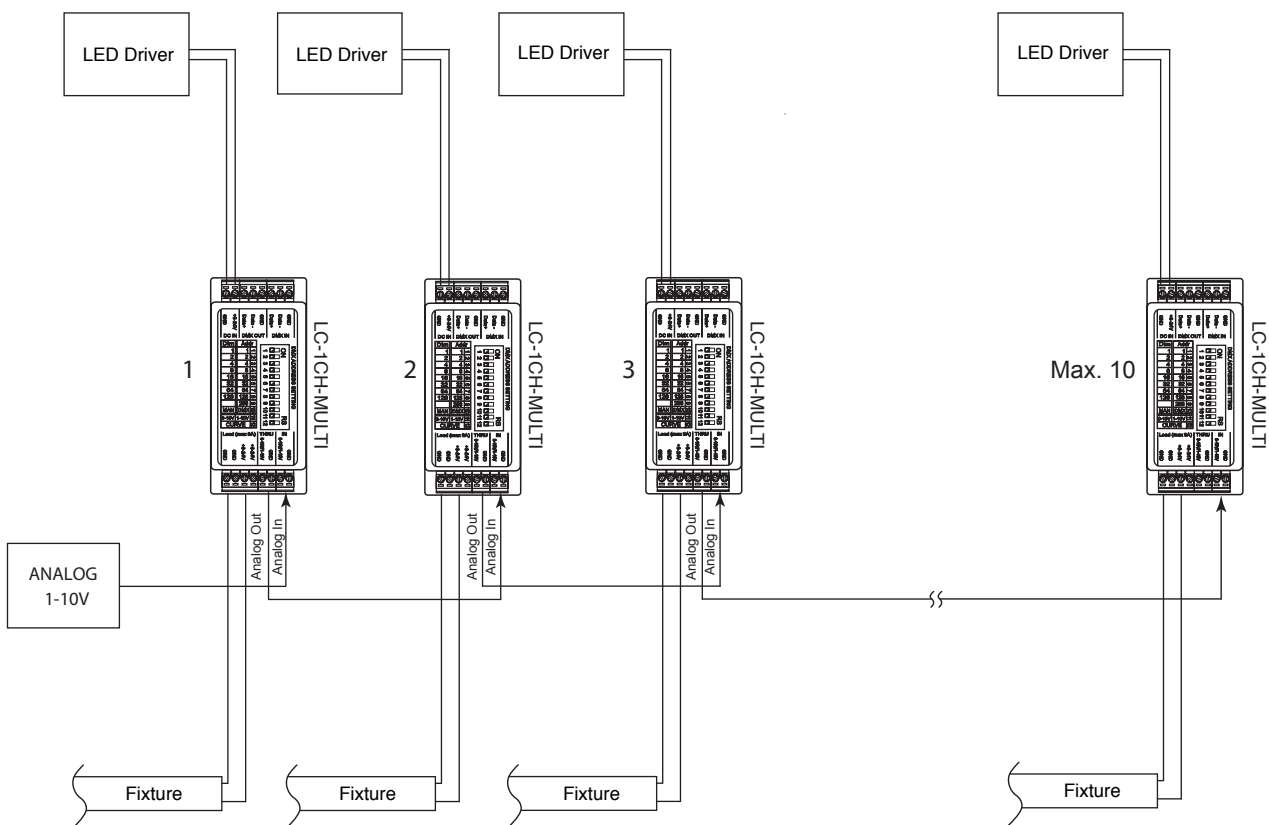
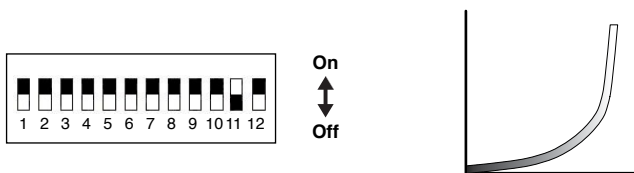

# Analog Setting 0-10VDC

For operation from devices using 0-10VDC protocol, flip dip-switch 11 to the “Off” position.

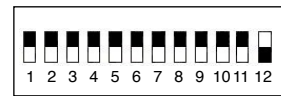

On  
↕  
Off

The 0-10VDC setting is not the norm in most cases, and requires the system to send a separate power signal to the dimming device. The dimming device derives its power from some external source in this case, and not from our LED Driver. Additionally, this setting is based upon the protocol 0VDC = Off, and other voltage values directly correlate to dim values (eg. 8VDC= 80% brightness level). The maximum number of dimmer packs to be connected in series is based upon the capacity of the dimming device.

## Dimming Curve

In this analog mode, there are two settings for the Dimming Curve.

With dip-switch 12 set to the “On” position, the Dimming Curve is Linear.

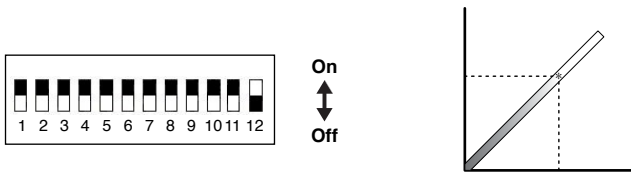

With dip-switch 12 set to the “Off” position, the Dimming Curve is Non-Linear.

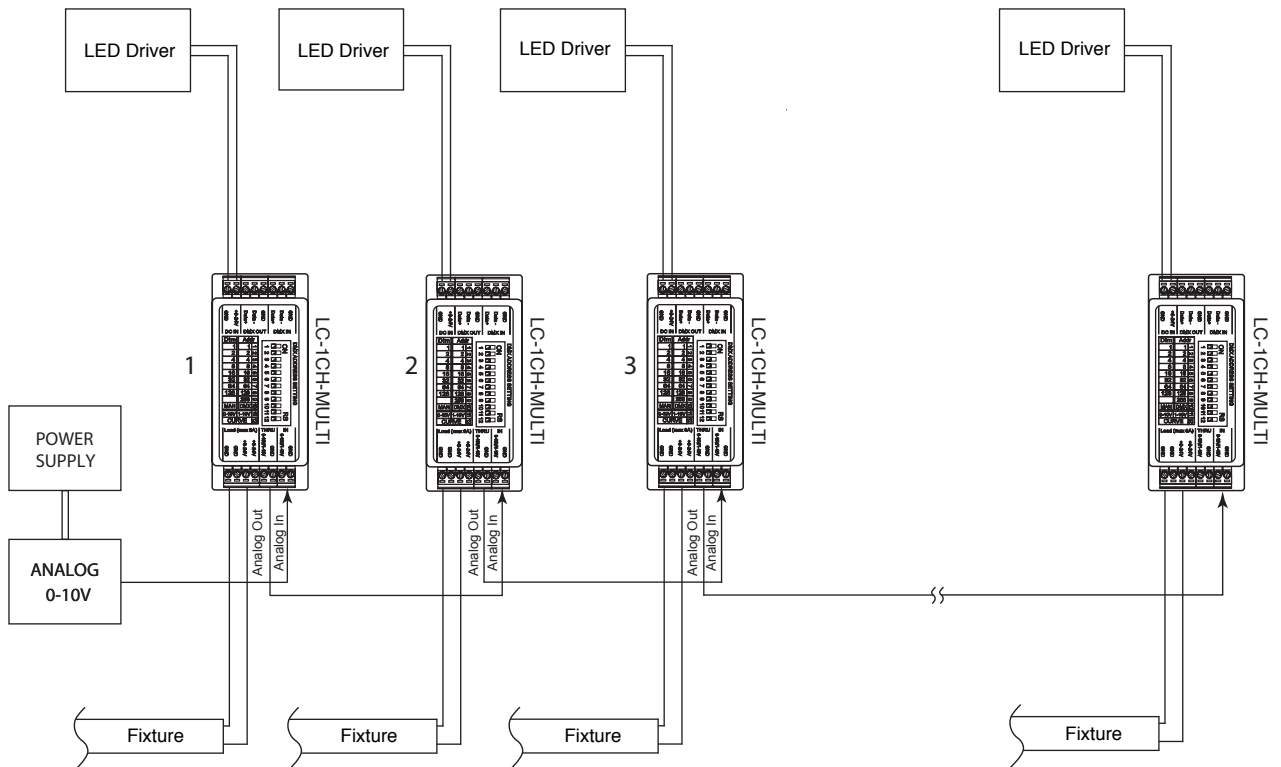
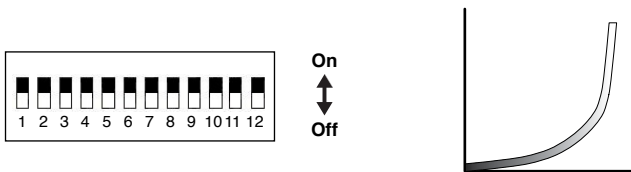

# Manual Control Mode

In this mode, dip-switches 10 and 11 are flipped to the “Off” position. Flip dip-switches 1~8 to set the intensity of LED product. Each dip-switch represents a binary value.

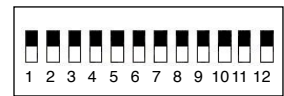

On  
↑  
↓  
Off

The intensity is set by combining the different dip-switches that will add up to the value you wish to achieve. The intensity value of 255 would represent full intensity

- Dip-Switch 1 address equals 1
- Dip-Switch 2 address equals 2
- Dip-Switch 3 address equals 4
- Dip-Switch 4 address equals 8
- Dip-Switch 5 address equals 16
- Dip-Switch 6 address equals 32
- Dip-Switch 7 address equals 64
- Dip-Switch 8 address equals 128

Intensity Value	Switches On	Intensity Value	Switches On
1	1	11	1,2,4
2	2	12	3,4
3	1,2	13	1,3,4
4	3	14	2,3,4
5	1,3	15	1,2,3,4
6	2,3	:	:
7	1,2,3	:	:
8	4	:	:
9	1,4	:	:
10	2,4	255	1,2,3,4,5,6,7,8

### Example 1

Dip Switch	Value
1	= 1
3	= 4
5	= 16
	= 21

### Example 2

Dip Switch	Value
1	= 1
4	= 8
7	= 64
8	= 128
	= 201

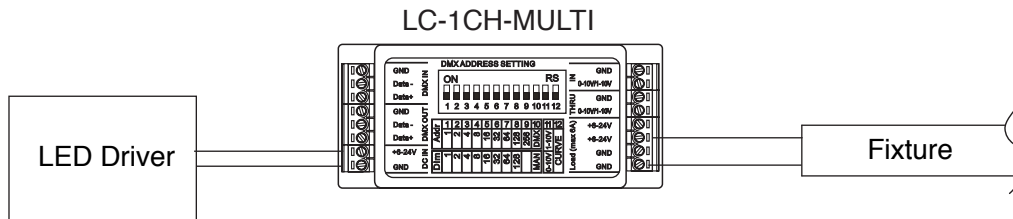

## TOKISTAR® LIGHTING

1015 E. Discovery Lane  
Anaheim, CA 92801

TEL: 714 772 7005 FAX: 714 772 7014

email: info@tokistar.com Website: tokistar.com